

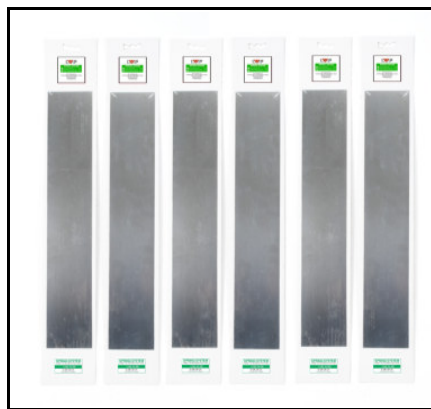

SPRING SYSTEM



 CATALOGO MOLLE INOX - ACCIAIO ARMONICO INOX AISI 301 - C67S - C100

 CATALOG STAINLESS STEEL SPRINGS - STAINLESS SPRING STEEL STRIP AISI 301 - SPRING STEEL HARDENED C67s - C100

 CATALOGUE RESSORT INOX - FEUILLES D'ACIER INOX AISI 301 PUOR RESSORT - ACIER AU CARBONE TREMPES C67S - C100

LWP Engineering s.r.l. Via Berlinguer n°6 , 43038 Sala Baganza (PR)

Tel / Fax +39 0521/834833

info@lwpengineering.com

www.lwpengineering.com



LWP Engineering s.r.l.

PI e CF 02538780343 - Via Berlinguer, 6 - 43038 Sala Baganza (Parma)

Tel e Fax: +39 0521/834833

E-mail : info@lwpengineering.com

www.lwpengineering.com

SPRING SYSTEM



MOLLE **COMPRESSIONE** INOX



COMPRESSION STAINLESS STEEL SPRINGS



RESSORTS **COMPRESSION** EN ACIER INOX



LWP Engineering s.r.l.

PI e CF 02538780343 - Via Berlinguer, 6 - 43038 Sala Baganza (Parma)

Tel e Fax: +39 0521/834833

E-mail : info@lwpengineering.com

www.lwpengineering.com

 **LISTINO MOLLE IN SPEZZONE A COMPRESSIONE INOX**

 **STAINLESS STEEL COMPRESSION SPRINGS LIST**

 **RESSORT COMPRESSION EN ACIER INOX**

Diametro Filo da 0,50 a 1,20 mm

Wire Diameter from 0,50 to 1,20 mm

Diametre Fil du 0,50 au 1,20 mm

 CODICE	FILO	Ø EST.	PASSO	LUNGHEZZA	MATERIALE
 CODE	WIRE DIAM.	Ø EXT.	STEP	LENGHT	MATERIAL
 CODE	FIL	Ø EXT.	PAS	LONGEUR	MATERIEL
CO 1	0,50	5	2	500	INOX
CO 118	0,50	6	2,50	500	INOX
CO 2	0,50	8	3	500	INOX
CO 119	0,50	9	3,50	500	INOX
CO 3	0,50	10	4	500	INOX
CO 4	0,80	5	2	500	INOX
CO 5	0,80	8	3,50	500	INOX
CO 120	0,80	9	3,50	500	INOX
CO 6	0,80	10	4	500	INOX
CO 7	0,80	12	4,50	500	INOX
CO 8	0,80	15	6	500	INOX
CO 9	1	5	2,20	500	INOX
CO 10	1	8	3	500	INOX
CO 121	1	9	3,50	500	INOX
CO 11	1	10	4	500	INOX
CO 12	1	12	5	500	INOX
CO 13	1	15	6	500	INOX
CO 14	1	16	6,50	500	INOX
CO 15	1	18	7	500	INOX
CO 16	1	20	8,50	500	INOX
CO 17	1,20	6	2,50	500	INOX
CO 56	1,20	6,50	2,50	500	INOX
CO 18	1,20	8	3,50	500	INOX
CO 122	1,20	9	3,50	500	INOX
CO 19	1,20	10	4	500	INOX
CO 20	1,20	12	5	500	INOX
CO 21	1,20	15	6	500	INOX



LWP Engineering s.r.l.

PI e CF 02538780343 - Via Berlinguer, 6 - 43038 Sala Baganza (Parma)

Tel e Fax: +39 0521/834833

E-mail : info@lwpengineering.com



www.lwpengineering.com

COMPRESSIONE – COMPRESSION – COMPRESSION

Diametro Filo da 1,20 a 2,20 mm

Wire Diameter from 1,20 to 2,20 mm

Diametre Fil du 1,20 au 2,20 mm

 CODICE	FILO	Ø EST.	PASSO	LUNGHEZZA	MATERIALE
 CODE	WIRE DIAM.	Ø EXT.	STEP	LENGHT	MATERIAL
 CODE	FIL	Ø EXT.	PAS	LONGEUR	MATERIEL
CO 57	1,20	18	8	500	INOX
CO 58	1,20	20	8,50	500	INOX
CO 22	1,50	8	3,50	500	INOX
CO 124	1,50	9	3,50	500	INOX
CO 23	1,50	10	4	500	INOX
CO 24	1,50	12	4,50	500	INOX
CO 25	1,50	15	6	500	INOX
CO 26	1,50	18	7,50	500	INOX
CO 27	1,50	20	8,50	500	INOX
CO 28	1,50	22	9	500	INOX
CO 29	1,50	25	10	500	INOX
CO 30	2	10	4	500	INOX
CO 31	2	12	4,50	500	INOX
CO 168	2	13	5	500	INOX
CO 32	2	15	6	500	INOX
CO 169	2	16	6,50	500	INOX
CO 33	2	18	7	500	INOX
CO 34	2	20	7,50	500	INOX
CO 35	2	22	8,50	500	INOX
CO 36	2	25	9,50	500	INOX
CO 37	2	28	10	500	INOX
CO 38	2	30	10,50	500	INOX
CO 125	2,20	12	4,50	500	INOX
CO 126	2,20	15	6	500	INOX
CO 127	2,20	18	7	500	INOX
CO 128	2,20	20	7,50	500	INOX
CO 129	2,20	22	8,50	500	INOX
CO 130	2,20	25	9,50	500	INOX
CO 131	2,20	28	10,50	500	INOX
CO 132	2,20	30	11	500	INOX
CO 133	2,20	35	13,50	500	INOX
CO 134	2,20	40	17	500	INOX



LWP Engineering s.r.l.

PI e CF 02538780343 - Via Berlinguer, 6 - 43038 Sala Baganza (Parma)

Tel e Fax: +39 0521/834833

E-mail : info@lwpengineering.com



www.lwpengineering.com

COMPRESSIONE – COMPRESSION – COMPRESSION

Diametro Filo da 2,50 a 3,00 mm

Wire Diameter from 2,50 to 3,00 mm

Diametre Fil du 2,50 au 3,00 mm

 CODICE	FILO	Ø EST.	PASSO	LUNGHEZZA	MATERIALE
 CODE	WIRE DIAM.	Ø EXT.	STEP	LENGHT	MATERIAL
 CODE	FIL	Ø EXT.	PAS	LONGEUR	MATERIEL
CO 39	2,50	15	6	500	INOX
CO 59	2,50	17	7	500	INOX
CO 40	2,50	18	6,50	500	INOX
CO 41	2,50	20	7,50	500	INOX
CO 42	2,50	22	8,50	500	INOX
CO 43	2,50	25	9,50	500	INOX
CO 44	2,50	28	10,50	500	INOX
CO 45	2,50	30	11	500	INOX
CO 166	2,50	32	11,50	500	INOX
CO 46	2,50	35	13,50	500	INOX
CO 167	2,50	38	15,50	500	INOX
CO 47	2,50	40	16,50	500	INOX
CO 48	3	15	6	500	INOX
CO 49	3	18	7	500	INOX
CO 50	3	20	7,50	500	INOX
CO 51	3	25	9,50	500	INOX
CO 52	3	28	10,50	500	INOX
CO 53	3	30	11	500	INOX
CO 54	3	35	12	500	INOX
CO 55	3	40	16	500	INOX
CO 60	3	45	18	500	INOX
CO 61	3	50	20	500	INOX



LWP Engineering s.r.l.

PI e CF 02538780343 - Via Berlinguer, 6 - 43038 Sala Baganza (Parma)

Tel e Fax: +39 0521/834833

E-mail : info@lwpengineering.com



www.lwpengineering.com

COMPRESSIONE – COMPRESSION – COMPRESSION

Diametro Filo da 3,50 a 4,00 mm

Wire Diameter from 3,50 to 4,00 mm

Diametre Fil du 3,50 au 4,00 mm

 CODICE	FILO	Ø EST.	PASSO	LUNGHEZZA	MATERIALE
 CODE	WIRE DIAM.	Ø EXT.	STEP	LENGHT	MATERIAL
 CODE	FIL	Ø EXT.	PAS	LONGEUR	MATERIEL
CO 137	3,50	18	7	200	INOX
CO 62	3,50	20	7,50	200	INOX
CO 138	3,50	22	8,50	200	INOX
CO 63	3,50	25	9,50	200	INOX
CO 139	3,50	28	10,50	200	INOX
CO 64	3,50	30	11,50	200	INOX
CO 140	3,50	32	12,50	200	INOX
CO 65	3,50	35	15,50	200	INOX
CO 141	3,50	38	15,50	200	INOX
CO 66	3,50	40	16,50	200	INOX
CO 142	3,50	42	17,50	200	INOX
CO 91	3,50	40	19,50	200	INOX
CO 67	3,50	45	17,50	200	INOX
CO 92	3,50	45	21,50	200	INOX
CO 143	3,50	48	18,50	200	INOX
CO 68	3,50	50	19,50	200	INOX
CO 93	3,50	50	24,50	200	INOX
CO 69	4	20	8	200	INOX
CO 165	4	23	8,5	200	INOX
CO 70	4	25	9	200	INOX
CO 144	4	28	10	200	INOX
CO 71	4	30	11,50	200	INOX
CO 145	4	32	11	200	INOX
CO 164	4	33	11	200	INOX
CO 72	4	35	13	200	INOX
CO 146	4	38	12,50	200	INOX
CO 73	4	40	13,50	200	INOX
CO 94	4	40	16,50	200	INOX
CO 147	4	42	14	200	INOX
CO 74	4	45	15	200	INOX
CO 95	4	45	17,50	200	INOX
CO 148	4	48	16,50	200	INOX



LWP Engineering s.r.l.

PI e CF 02538780343 - Via Berlinguer, 6 - 43038 Sala Baganza (Parma)

Tel e Fax: +39 0521/834833

E-mail : info@lwpengineering.com



www.lwpengineering.com

COMPRESSIONE – COMPRESSION – COMPRESSION

Diametro Filo da 4,00 a 5,00 mm

Wire Diameter from 4,00 to 5,00 mm

Diametre Fil du 4,00 au 5,00 mm

 CODICE	FILO	Ø EST.	PASSO	LUNGHEZZA	MATERIALE
 CODE	WIRE DIAM.	Ø EXT.	STEP	LENGHT	MATERIAL
 CODE	FIL	Ø EXT.	PAS	LONGEUR	MATERIEL
CO 75	4	50	17,50	200	INOX
CO 96	4	50	21,50	200	INOX
CO 76	4,50	20	8	200	INOX
CO 149	4,50	22	7,50	200	INOX
CO 77	4,50	25	9	200	INOX
CO 150	4,50	28	10	200	INOX
CO 78	4,50	30	10,50	200	INOX
CO 151	4,50	32	11,50	200	INOX
CO 79	4,50	35	14,50	200	INOX
CO 152	4,50	38	13,50	200	INOX
CO 80	4,50	40	16,50	200	INOX
CO 153	4,50	42	15	200	INOX
CO 81	4,50	45	16	200	INOX
CO 97	4,50	45	19,50	200	INOX
CO 154	4,50	48	16,50	200	INOX
CO 82	4,50	50	17,50	200	INOX
CO 98	4,50	50	21,50	200	INOX
CO 83	5	25	9,50	200	INOX
CO 155	5	28	11	200	INOX
CO 84	5	30	13,50	200	INOX
CO 156	5	32	13	200	INOX
CO 85	5	35	14	200	INOX
CO 99	5	35	16	200	INOX
CO 157	5	38	15	200	INOX
CO 86	5	40	16	200	INOX
CO 100	5	40	19,50	200	INOX
CO 158	5	42	17	200	INOX
CO 87	5	45	18	200	INOX
CO 101	5	45	22,50	200	INOX
CO 88	5	50	19,50	200	INOX
CO 102	5	50	24	200	INOX
CO 89	5	55	22	200	INOX



LWP Engineering s.r.l.

PI e CF 02538780343 - Via Berlinguer, 6 - 43038 Sala Baganza (Parma)

Tel e Fax: +39 0521/834833

E-mail : info@lwpengineering.com



www.lwpengineering.com

COMPRESSIONE – COMPRESSION – COMPRESSION

Diametro Filo da 5,00 a 6,00 mm

Wire Diameter from 5,00 to 6,00 mm

Diametre Fil du 5,00 au 6,00 mm

 CODICE	FILO	Ø EST.	PASSO	LUNGHEZZA	MATERIALE
 CODE	WIRE DIAM.	Ø EXT.	STEP	LENGHT	MATERIAL
 CODE	FIL	Ø EXT.	PAS	LONGEUR	MATERIEL
CO 103	5	55	27,50	200	INOX
CO 90	5	60	24	200	INOX
CO 104	5	60	32	200	INOX
CO 105	5,50	30	12	200	INOX
CO 106	5,50	35	13	200	INOX
CO 107	5,50	40	15	200	INOX
CO 108	5,50	45	17	200	INOX
CO 109	5,50	50	18	200	INOX
CO 110	5,50	55	20	200	INOX
CO 111	5,50	60	24	200	INOX
CO 159	6	30	11	200	INOX
CO 160	6	32	11,50	200	INOX
CO 112	6	35	13	200	INOX
CO 161	6	38	13,50	200	INOX
CO 113	6	40	15	200	INOX
CO 162	6	42	15	200	INOX
CO 114	6	45	16	200	INOX
CO 163	6	48	16,50	200	INOX
CO 115	6	50	18	200	INOX
CO 116	6	55	20	200	INOX
CO 117	6	60	22	200	INOX



LWP Engineering s.r.l.

PI e CF 02538780343 - Via Berlinguer, 6 - 43038 Sala Baganza (Parma)

Tel e Fax: +39 0521/834833

E-mail : info@lwpengineering.com

www.lwpengineering.com

SPRING SYSTEM

COMPRESSIONE – COMPRESSION – COMPRESSION

DIAMETRO DEL FILO – DIAMETRO ESTERNO WIRE DIAMETER – OUTSIDE DIAMETER

DIAMETRE DU FIL – DIAMETRE EXTERIEUR

Ø Ø. Est	0,5	0,8	1	1,2	1,5	2	2,2	2,5	3	3,5	4	4,5	5	5,5	6
5	CO1	CO4	CO9												
6	CO118			CO17											
6,5				CO56											
8	CO2	CO5	CO10	CO18	CO22										
9	CO119	CO120	CO121	CO122	CO124										
10	CO3	CO6	CO11	CO19	CO23	CO30									
12		CO7	CO12	CO20	CO24	CO31	CO125								
13						CO168									
15		CO8	CO13	CO21	CO25	CO32	CO126	CO39	CO48						
16			CO14			CO169									
17								CO/59							
18			CO15	CO57	CO26	CO33	CO127	CO40	CO49	CO137					
20			CO16	CO58	CO27	CO34	CO128	CO41	CO50	CO62	CO69	CO76			
22					CO28	CO35	CO129	CO42	CO136	CO138		CO149			
23											CO165				
25					CO29	CO36	CO130	CO43	CO51	CO63	CO70	CO77	CO83		
28						CO37	CO131	CO44	CO52	CO/39	CO144	CO150	CO155		
30						CO38	CO132	CO45	CO53	CO64	CO71	CO78	CO84	CO105	CO159
32								CO166		CO140	CO145	CO151	CO156		CO160
33											CO164				
35							CO133	CO46	CO54	CO65	CO72	CO79	CO85 CO99	CO106	CO112
38								CO167		CO141	CO146	CO152	CO157		CO161
40							CO134	CO47	CO55	CO66 CO91	CO73 CO94	CO80	CO86 CO100	CO107	CO113
42										CO142	CO147	CO153	CO158		CO162
45									CO60	CO67 CO92	CO74 CO95	CO81 CO97	CO87 CO101	CO108	CO114
48										CO143	CO148	CO154			CO163
50									CO61	CO68 CO93	CO75 CO96	CO82 CO98	CO88 CO102	CO109	CO115
55													CO89 CO103	CO110	CO/16
60													CO90 CO104	CO111	CO117



LWP Engineering s.r.l.

PI e CF 02538780343 - Via Berlinguer, 6 - 43038 Sala Baganza (Parma)

Tel e Fax: +39 0521/834833

E-mail : info@lwpengineering.com

www.lwpengineering.com

SCHEMA MOLLA / SPRING LAYOUT / FICHE RESSORT

RICHIESTA / REQUEST / DEMAND :

OFFERTA / OFFER / DEVIS

ORDINE / ORDER / ORDRE

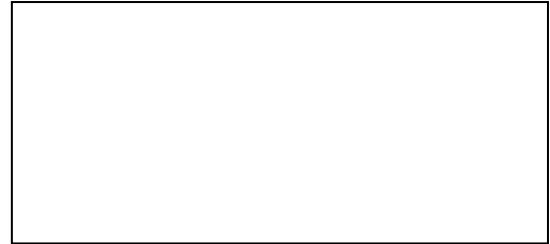

DITTA / COMPANY / SOCIETE'

QUANTITA' / Q.TY / QUANTITE' : N° _____

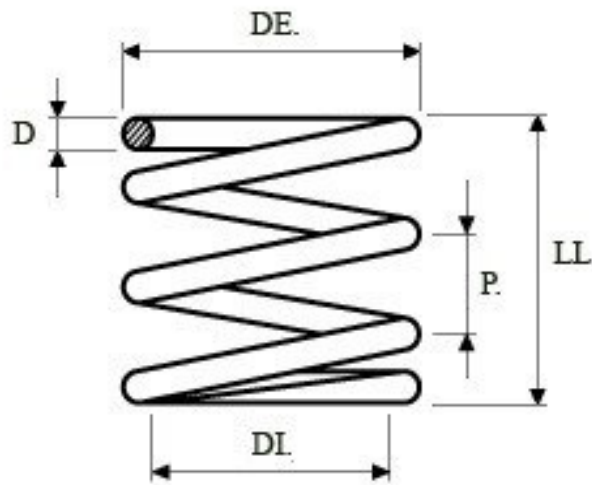

CARATTERISTICHE / SPECIFICATIONS / CARACTERISTIQUES

D. = Ø FILO / Ø WIRE / Ø FIL : _____

DE. = Ø ESTERNO / Ø OUTSIDE / Ø EXTERIEUR : _____

DI. = Ø INTERNO / Ø INSIDE / Ø INTERIEUR : _____

P. = PASSO / WIRE STEP / PAS : _____

LL. = LUNGHEZZA / LENGHT / LONGHEUR : _____

ST. = N° DI SPIRE / WIRE NUMBER / N° SPIRES : _____

ESTREMITA' / ENDS / EXTREMITES :

MOLATE / GROUNDED / MEULEES

RAVVICINATE / CLOSED / RAPPROCHEES

MATERIALE / MATERIAL / MATERIEL :

INOX / STAINLESS STEEL / INOX

AISI 302

AISI 316

ACCIAIO / STEEL / ACIER

C/85

C/98



LWP Engineering s.r.l.

PI e CF 02538780343 - Via Berlinguer, 6 - 43038 Sala Baganza (Parma)

Tel e Fax: +39 0521/834833

E-mail : info@lwpengineering.com

www.lwpengineering.com

SCHEMA MOLLA / SPRING LAYOUT / FICHE RESSORT

SEZIONE RETTANGOLARE / RECTANGULAR SECTION / SECTION RECTANGULAIRE

RICHIESTA / REQUEST / DEMAND :

- OFFERTA / OFFER / DEVIS
- ORDINE / ORDER / ORDRE

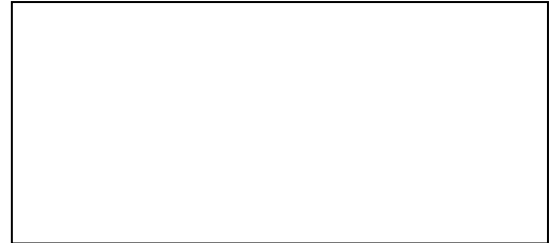

DITTA / COMPANY / SOCIETE'

QUANTITA' / Q.TY / QUANTITE' : N° _____

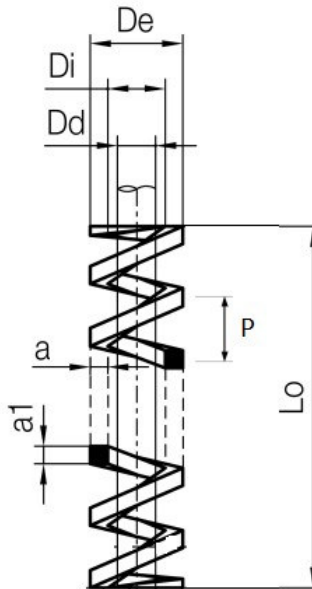

CARATTERISTICHE / SPECIFICATIONS / CARACTERISTIQUES

a / a1 = DIM. FILO / DIM. WIRE / DIM FIL : _____ / _____

De = Ø ESTERNO / Ø OUTSIDE / Ø EXTERIEUR : _____

Di = Ø INTERNO / Ø INSIDE / Ø INTERIEUR : _____

P = PASSO / WIRE STEP / PAS : _____

L0 = LUNGHEZZA / LENGHT / LONGHEUR : _____

ST. = N° DI SPIRE / WIRE NUMBER / N° SPIRES : _____

ESTREMITA' / ENDS / EXTREMITES :

MOLATE / GROUNDED / MEULEES

RAVVICINATE / CLOSED / RAPPROCHEES

MATERIALE / MATERIAL / MATERIEL :

INOX / STAINLESS STEEL / INOX AISI 302

ACCIAIO / STEEL / ACIER



LWP Engineering S.r.l.

PI e CF 02538780343 - Via Berlinguer, 6 - 43038 Sala Baganza (Parma)

Tel e Fax: +39 0521/834833

E-mail : info@lwpengineering.com

www.lwpengineering.com

SPRING SYSTEM



MOLLE IN SPEZZONE A **TRAZIONE** INOX



EXTENSION STAINLESS STEEL SPRINGS



RESSORTS **TRACTION** EN ACIER INOX



LWP Engineering S.r.l.

PI e CF 02538780343 - Via Berlinguer, 6 - 43038 Sala Baganza (Parma)

Tel e Fax: +39 0521/834833

E-mail : info@lwpengineering.com

www.lwpengineering.com

 **LISTINO MOLLE IN SPEZZONE A TRAZIONE INOX**

 **STAINLESS STEEL EXTENSION SPRINGS CATALOG**

 **RESSORT TRACTION EN ACIER INOX**

Diametro Filo da 0,50 a 1,50 mm

Wire Diameter from 0,50 to 1,50 mm

Diametre Fil du 0,50 au 1,50 mm

 CODICE	FILO	Ø EST.	PASSO	LUNGHEZZA	MATERIALE
 CODE	WIRE DIAM.	Ø EXT.	STEP	LENGHT	MATERIAL
 CODE	FIL	Ø EXT.	PAS	LONGEUR	MATERIEL
TO 1	0,50	5	*	500	INOX
TO 2	0,50	8	*	500	INOX
TO 3	0,50	10	*	500	INOX
TO 4	0,80	6	*	500	INOX
TO 5	0,80	8	*	500	INOX
TO 6	0,80	10	*	500	INOX
TO 7	0,80	12	*	500	INOX
TO 8	0,80	15	*	500	INOX
TO 9	1	6	*	500	INOX
TO 10	1	8	*	500	INOX
TO 44	1	9	*	500	INOX
TO 11	1	10	*	500	INOX
TO 12	1	12	*	500	INOX
TO 13	1	13	*	500	INOX
TO 14	1	14	*	500	INOX
TO 15	1	15	*	500	INOX
TO 16	1,20	8	*	500	INOX
TO 17	1,20	10	*	500	INOX
TO 18	1,20	12	*	500	INOX
TO 19	1,20	15	*	500	INOX
TO 20	1,50	8	*	500	INOX
TO 21	1,50	10	*	500	INOX
TO 22	1,50	12	*	500	INOX
TO 23	1,50	15	*	500	INOX
TO 24	1,50	18	*	500	INOX
TO 25	1,50	20	*	500	INOX



LWP Engineering S.r.l.

PI e CF 02538780343 - Via Berlinguer, 6 - 43038 Sala Baganza (Parma)

Tel e Fax: +39 0521/834833

E-mail : info@lwpengineering.com



www.lwpengineering.com

TRAZIONE – EXTENSION – TRACTION

Diametro Filo da 1,50 a 2,50 mm

Wire Diameter from 1,50 to 2,50 mm

Diametre Fil du 1,50 au 2,50 mm

 CODICE	FILO	Ø EST.	PASSO	LUNGHEZZA	MATERIALE
 CODE	WIRE DIAM.	Ø EXT.	STEP	LENGHT	MATERIAL
 CODE	FIL	Ø EXT.	PAS	LONGEUR	MATERIEL
TO 26	1,50	22	*	500	INOX
TO 27	1,50	25	*	500	INOX
TO 45	1,80	6,90	*	500	INOX
TO 28	2	12	*	500	INOX
TO 29	2	15	*	500	INOX
TO 30	2	18	*	500	INOX
TO 31	2	20	*	500	INOX
TO 32	2	22	*	500	INOX
TO 33	2	25	*	500	INOX
TO 34	2	28	*	500	INOX
TO 35	2	30	*	500	INOX
TO 36	2,50	12	*	500	INOX
TO 37	2,50	15	*	500	INOX
TO 38	2,50	18	*	500	INOX
TO 39	2,50	20	*	500	INOX
TO 40	2,50	22	*	500	INOX
TO 41	2,50	25	*	500	INOX
TO 42	2,50	28	*	500	INOX
TO 43	2,50	30	*	500	INOX



LWP Engineering S.r.l.

PI e CF 02538780343 - Via Berlinguer, 6 - 43038 Sala Baganza (Parma)

Tel e Fax: +39 0521/834833

E-mail : info@lwpengineering.com

www.lwpengineering.com

SPRING SYSTEM

TRAZIONE – EXTENSION – TRACTION

DIAMETRO DEL FILO – DIAMETRO ESTERNO

WIRE DIAMETER – OUTSIDE DIAMETER

DIAMETRE DU FIL – DIAMETRE EXTERIEUR

\varnothing Ø. Est	0,5	0,8	1	1,20	1,50	1,8	2	2,5
5	TO/1							
6		TO/4	TO/9					
6,5						TO/45		
8	TO/2	TO/5	TO/10	TO/16	TO/20			
9			TO/44					
10	TO/3	TO/6	TO/11	TO/17	TO/21			
12		TO/7	TO/12	TO/18	TO/22		TO/28	TO/36
13			TO/13					
14			TO/14					
15		TO/8	TO/15	TO/19	TO/23		TO/29	TO37
18					TO/24		TO/30	TO/38
20					TO/25		TO/31	TO39
22					TO/26		TO/32	TO/40
25					TO/27		TO/33	TO/41
28							TO/34	TO/42
30							TO/35	TO/43



LWP Engineering S.r.l.

PI e CF 02538780343 - Via Berlinguer, 6 - 43038 Sala Baganza (Parma)

Tel e Fax: +39 0521/834833

E-mail : info@lwpengineering.com

www.lwpengineering.com

SCHEMA MOLLA / SPRING LAYOUT / FICHE RESSORT

RICHIESTA / REQUEST / DEMAND :

OFFERTA / OFFER / DEVIS

ORDINE / ORDER / ORDRE



DITTA / COMPANY / SOCIETE'

QUANTITA' / Q.TY / QUANTITE' : N° _____

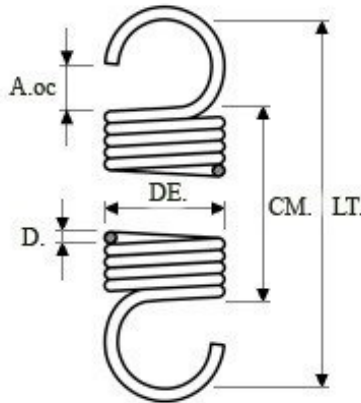

CARATTERISTICHE / SPECIFICATIONS / CARACTERISTIQUES

D. = Ø FILO / Ø WIRE / Ø FIL : _____

DE. = Ø ESTERNO / Ø OUTSIDE / Ø EXTERIEUR : _____

CM. = LUNGHEZZA / LENGHT / LONGHEUR : _____

LT. = LUNGHEZZA / LENGHT / LONGHEUR : _____

A.oc = APERTURA OCCHI : _____

OCCHI / HOOK / ANNEAU:



MATERIALE / MATERIAL / MATERIEL :

INOX / STAINLESS STEEL / INOX

AISI 302

AISI 316

ACCIAIO / STEEL / ACIER

C/85

C/98



LWP Engineering s.r.l.

PI e CF 02538780343 - Via Berlinguer, 6 - 43038 Sala Baganza (Parma)

Tel e Fax: +39 0521/834833

E-mail : info@lwpengineering.com

www.lwpengineering.com

FILO ARMONICO SPRING SYSTEM



FILO ARMONICO **INOX AISI 302** e **C/85 - C/72**



HARMONIC STEEL WIRE **AISI 302** and **C/85 - C/72**





FIL D'ACIER POUR RESSORTS **INOX 302** et **C/85 - C/72**

FILO ARMONICO INOX AISI 302

HARMONIC STAINLESS STEEL WIRE AISI 302

FIL D'ACIER PUOR RESSORTS INOX AISI 302

Diametro Filo da 0,20 a 2,00 mm in bobine da 500 grammi
Wire Diameter from 0,20 to 2,00 mm in 500 gram reels
Diamètre du fil de 0,20 à 2,00 mm en bobines de 500 grammes

 CODICE	Ø FILO	PESO (gr)	METRI (m)	MATERIALE
 CODE	THICKNESS	WIDTH	LENGHT	MATERIAL
 CODE	EPAISSEUR	LARGEUR	LONGEUR	MATERIEL
FI 020 500	0,20	500	1990	INOX AISI 302
FI 030 500	0,30	500	885	INOX AISI 302
FI 040 500	0,40	500	498	INOX AISI 302
FI 050 500	0,50	500	318	INOX AISI 302
FI 060 500	0,60	500	221	INOX AISI 302
FI 070 500	0,70	500	162	INOX AISI 302
FI 080 500	0,80	500	124	INOX AISI 302
FI 090 500	0,90	500	98	INOX AISI 302
FI 100 500	1	500	80	INOX AISI 302
FI 120 500	1,20	500	55	INOX AISI 302
FI 130 500	1,30	500	47	INOX AISI 302
FI 140 500	1,40	500	41	INOX AISI 302
FI 150 500	1,50	500	35	INOX AISI 302
FI 160 500	1,60	500	31	INOX AISI 302
FI 180 500	1,80	500	25	INOX AISI 302
FI 200 500	2	500	20	INOX AISI 302



* Disponibili a richiesta anche altri diametri.

FILO ARMONICO INOX AISI 302 IN BARRE

HARMONIC STAINLESS STEEL WIRE AISI 302 IN BARS

FIL D'ACIER POUR RESSORTS INOX AISI 302 EN BARRES

Diametro Filo da 0,80 a 8,00 mm in barre
Wire Diameter from 0,80 to 8,00 mm in bars
Diamètre du fil de 0,80 à 8,00 mm en barres



 CODICE	Ø FILO	PESO (gr)	METRI (m)	MATERIALE
 CODE	THICKNESS	WIDTH	LENGHT	MATERIAL
 CODE	EPAISSEUR	LARGEUR	LONGEUR	MATERIEL
FI 080 1000	0,80	-	1	INOX AISI 302
FI 100 1500	1	-	1,5	INOX AISI 302
FI 120 1500	1,20	-	1,5	INOX AISI 302
FI 150 2000	1,50	-	2	INOX AISI 302
FI 170 1000	1,70	-	1	INOX AISI 302
FI 170 1500	1,70	-	1,5	INOX AISI 302
FI 180 2000	1,80	-	2	INOX AISI 302
FI 200 2000	2	-	2	INOX AISI 302
FI 250 2000	2,50	-	2	INOX AISI 302
FI 300 2000	3	-	2	INOX AISI 302
FI 350 3000	3,50	-	3	INOX AISI 302
FI 400 2000	4	-	2	INOX AISI 302
FI 316L 450 3000	4,50	-	3	INOX AISI 316 L
FI 316L 500 3000	5	-	3	INOX AISI 316 L
FI 316L 600 3000	6	-	3	INOX AISI 316 L
FI 700 3000	7	-	3	INOX AISI 302
FI 800 3000	8	-	3	INOX AISI 302

FILO ARMONICO C/85

HARMONIC STEEL WIRE C/85

FIL D'ACIER POUR RESSORTS C/85

Diametro Filo da 0,20 a 2,00 mm in bobine da 500 grammi.
Wire Diameter from 0,20 to 2,00 mm in 500 gram reels.
Diamètre du fil de 0,20 à 2,00 mm en bobines de 500 grammes.

 CODICE	Ø FILO	PESO (gr)	METRI (m)	MATERIALE
 CODE	THICKNESS	WIDTH	LENGHT	MATERIAL
 CODE	EPAISSEUR	LARGEUR	LONGEUR	MATERIEL
F 020 500	0,20	500	1990	C/85
F 030 500	0,30	500	885	C/85
F 040 500	0,40	500	498	C/85
F 050 500	0,50	500	318	C/85
F 060 500	0,60	500	221	C/85
F 070 500	0,70	500	162	C/85
F 080 500	0,80	500	124	C/85
F 090 500	0,90	500	98	C/85
F 100 500	1	500	80	C/85
F 120 500	1,20	500	55	C/85
F 130 500	1,30	500	47	C/85
F 140 500	1,40	500	41	C/85
F 150 500	1,50	500	35	C/85
F 160 500	1,60	500	31	C/85
F 180 500	1,80	500	25	C/85
F 200 500	2	500	20	C/85



*** Disponibili a richiesta anche Bobine da 100 grammi.**

FILO ARMONICO C/72

HARMONIC STEEL WIRE C/72

FIL D'ACIER POUR RESSORTS C/72

Diametro Filo da 0,20 a 2,00 mm in bobine da 10 metri.
Wire Diameter from 0,20 to 2,00 mm in 10 meter reels.
Diamètre du fil de 0,20 à 2,00 mm en bobines de 10 mètres.

 CODICE	Ø FILO	PESO (gr)	METRI (m)	MATERIALE
 CODE	THICKNESS	WIDTH	LENGHT	MATERIAL
 CODE	EPAISSEUR	LARGEUR	LONGEUR	MATERIEL
F 020 010	0,20	2,51	10	C/72
F 030 010	0,30	5,65	10	C/72
F 040 010	0,40	10	10	C/72
F 050 010	0,50	16	10	C/72
F 060 010	0,60	23	10	C/72
F 070 010	0,70	29	10	C/72
F 080 010	0,80	40	10	C/72
F 090 010	0,90	51	10	C/72
F 100 010	1	62,50	10	C/72
F 120 010	1,20	90	10	C/72
F 130 010	1,30	106	10	C/72
F 140 010	1,40	122	10	C/72
F 150 010	1,50	143	10	C/72
F 160 010	1,60	161	10	C/72
F 180 010	1,80	200	10	C/72
F 200 010	2	250	10	C/72



LWP Engineering s.r.l.

PI e CF 02538780343 - Via Berlinguer, 6 - 43038 Sala Baganza (Parma)

Tel e Fax: +39 0521/834833

E-mail : info@lwpengineering.com

www.lwpengineering.com

FILO ARMONICO INOX AISI 316

SPRING SYSTEM



FILO ARMONICO **INOX AISI 316**



HARMONIC STAINLESS STEEL WIRE **AISI 316**





FIL D'ACIER POUR RESSORTS **INOX 316**

FILO ARMONICO INOX AISI 316

HARMONIC STAINLESS STEEL WIRE AISI 316

FIL D'ACIER PUOR RESSORTS INOX AISI 316

Diametro Filo da 0,20 a 2,00 mm in bobine da 500 grammi
Wire Diameter from 0,20 to 2,00 mm in 500 gram reels
Diamètre du fil de 0,20 à 2,00 mm en bobines de 500 grammes

 CODICE	Ø FILO	PESO (gr)	METRI (m)	MATERIALE
 CODE	THICKNESS	WIDTH	LENGHT	MATERIAL
 CODE	EPAISSEUR	LARGEUR	LONGEUR	MATERIEL
FI 316 020 500	0,20	500	1990	INOX AISI 316
FI 316 030 500	0,30	500	885	INOX AISI 316
FI 316 040 500	0,40	500	498	INOX AISI 316
FI 316 050 500	0,50	500	318	INOX AISI 316
FI 316 060 500	0,60	500	221	INOX AISI 316
FI 316 070 500	0,70	500	162	INOX AISI 316
FI 316 080 500	0,80	500	124	INOX AISI 316
FI 316 090 500	0,90	500	98	INOX AISI 316
FI 316L 100 500	1	500	80	INOX AISI 316 L
FI 316 120 500	1,20	500	55	INOX AISI 316
FI 316 130 500	1,30	500	47	INOX AISI 316
FI 316 140 500	1,40	500	41	INOX AISI 316
FI 316L 150 500	1,50	500	35	INOX AISI 316 L
FI 316 160 500	1,60	500	31	INOX AISI 316
FI 316 180 500	1,80	500	25	INOX AISI 316
FI 316L 200 500	2	500	20	INOX AISI 316 L



LWP Engineering s.r.l.

PI e CF 02538780343 - Via Berlinguer, 6 - 43038 Sala Baganza (Parma)

Tel e Fax: +39 0521/834833

E-mail : info@lwpengineering.com

www.lwpengineering.com

SPRING SYSTEM BOX



CASSETTIERA MOLLE COMPRESSIONE INOX



COMPRESSION STAINLESS STEEL SPRINGS BOX



BOITE DE RESSORTS COMPRESSION EN INOX



LWP Engineering s.r.l.

PI e CF 02538780343 - Via Berlinguer, 6 - 43038 Sala Baganza (Parma)

Tel e Fax: +39 0521/834833

E-mail : info@lwpengineering.com

www.lwpengineering.com



CASSETTIERA MOLLE COMPRESSIONE INOX

TIPO

“A”



STAINLESS STEEL COMPRESSION SPRING BOX

TYPE

“A”



BOITE RESSORT COMPRESSION EN ACIER INOX

TYPE

“A”

Diametro Filo da 0,50 a 1,20 mm

Wire Diameter from 0,50 to 1,20 mm

Diametre Fil du 0,50 au 1,20 mm

CODICE	POS	FILO	Ø EST.	PASSO	LUNGHEZZA	MATERIALE	N° PEZZI
CODE	POSITION	WIRE DIAM.	Ø EXT.	STEP	LENGHT	MATERIAL	N° PIECES
CODE	POSITION	FIL	Ø EXT.	PAS	LONGEUR	MATERIEL	N° PIECES
MCO 62 A	1	0,50	6	2,5	50	INOX	10
MCO 2 A	2	0,50	8	3	50	INOX	10
MCO 3 A	3	0,50	10	4	50	INOX	10
MCO 63 A	4	0,80	6	3,5	50	INOX	10
MCO 5 A	5	0,80	8	3,5	50	INOX	10
MCO 6 A	6	0,80	10	4	50	INOX	10
MCO 7 A	7	0,80	12	4,5	50	INOX	8
MCO 8 A	8	0,80	15	6	50	INOX	8
MCO 10 A	9	1	8	3	50	INOX	10
MCO 11 A	10	1	10	4	50	INOX	10
MCO 12 A	11	1	12	5	50	INOX	8
MCO 13 A	12	1	15	6	50	INOX	6
MCO 18 A	13	1,20	8	3,5	50	INOX	10
MCO 19 A	14	1,20	10	4	50	INOX	10
MCO 20 A	15	1,20	12	5	50	INOX	8
MCO 21 A	16	1,20	15	6	50	INOX	6

* N°144 PEZZI TOTALI CASSETTIERA TIPO “A” / N°144 PIECES BOX TYPE “A” / N° 144 PIECES BOITE TYPE “A”



LWP Engineering s.r.l.

PI e CF 02538780343 - Via Berlinguer, 6 - 43038 Sala Baganza (Parma)

Tel e Fax: +39 0521/834833

E-mail : info@lwpengineering.com

www.lwpengineering.com



CASSETTIERA MOLLE COMPRESSIONE INOX

TIPO "B"



STAINLESS STEEL COMPRESSION SPRING BOX

TYPE "B"



BOITE RESSORT COMPRESSION EN ACIER INOX

TYPE "B"

Diametro Filo da 1,50 a 2,00 mm

Wire Diameter from 1,50 to 2,00 mm

Diametre Fil du 1,50 au 2,00 mm

CODICE	POS	FILO	Ø EST.	PASSO	LUNGHEZZA	MATERIALE	N° PEZZI
CODE	POSITION	WIRE DIAM.	Ø EXT.	STEP	LENGHT	MATERIAL	N° PIECES
CODE	POSITION	FIL	Ø EXT.	PAS	LONGEUR	MATERIEL	N° PIECES
MCO 22 B	17	1,50	8	3,5	50	INOX	10
MCO 23 B	18	1,50	10	4	50	INOX	10
MCO 24 B	19	1,50	12	4,5	50	INOX	8
MCO 25 B	20	1,50	15	6	50	INOX	6
MCO 26 B	21	1,50	18	7,5	50	INOX	6
MCO 27 B	22	1,50	20	8,5	50	INOX	6
MCO 28 B	23	1,50	22	9	50	INOX	4
MCO 29 B	24	1,50	25	10	50	INOX	4
MCO 30 B	25	2	10	4	50	INOX	8
MCO 31 B	26	2	12	4,5	50	INOX	8
MCO 32 B	27	2	15	6	50	INOX	6
MCO 33 B	28	2	18	7	50	INOX	4
MCO 34 B	29	2	20	7,5	50	INOX	4
MCO 35 B	30	2	22	8,5	50	INOX	2
MCO 36 B	31	2	25	9,5	50	INOX	2
MCO 38 B	32	2	30	10,5	50	INOX	2

* N° 90 PEZZI TOTALI CASSETTIERA TIPO "B" / N° 90 PIECES BOX TYPE "B" / N° 90 PIECES BOITE TYPE "B"



LWP Engineering s.r.l.

PI e CF 02538780343 - Via Berlinguer, 6 - 43038 Sala Baganza (Parma)

Tel e Fax: +39 0521/834833

E-mail : info@lwpengineering.com

www.lwpengineering.com

ACCIAIO ARMONICO INOX

SPRING SYSTEM

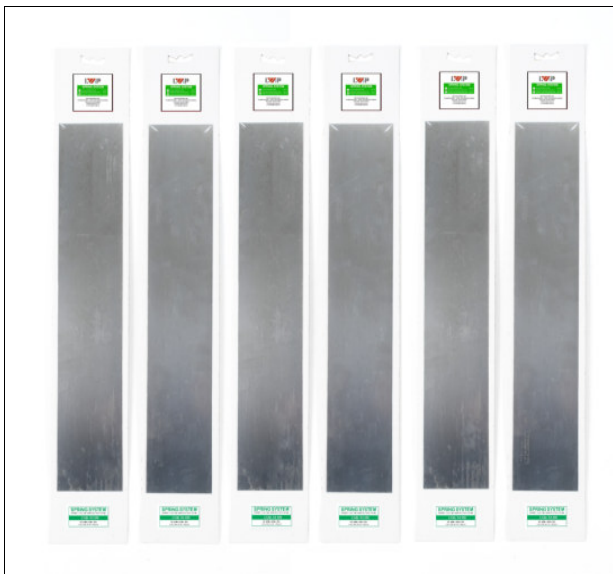

BANDELLE ACCIAIO ARMONICO INOX AISI 301



HARMONIC STAINLESS SPRING STEEL STRIP AISI 301



FEUILLES D'ACIER INOX POUR RESSORT AISI 301



LWP Engineering s.r.l.

PI e CF 02538780343 - Via Berlinguer, 6 - 43038 Sala Baganza (Parma)

Tel e Fax: +39 0521/834833

E-mail : info@lwpengineering.com

www.lwpengineering.com

ACCIAIO ARMONICO INOX AISI 301

Dimensione – Size - Dimension:



100 x 500 mm



Spessore da 0,05 a 1,00 mm Dimensione 100 x 500 mm

Thickness from 0,05 to 1,00 mm Dimension 100 x 500 mm

Epaisseur du 0,05 au 1,00 mm Dimension 100 x 500 mm

 CODICE	SPESSORE	LARGHEZZA	LUNGHEZZA	MATERIALE
 CODE	THICKNESS	WIDTH	LENGHT	MATERIAL
 CODE	EPAISSEUR	LARGEUR	LONGEUR	MATERIEL
NI 005	0,05	100	500	AISI 301
NI 010	0,10	100	500	AISI 301
NI 015	0,15	100	500	AISI 301
NI 020	0,20	100	500	AISI 301
NI 025	0,25	100	500	AISI 301
NI 030	0,30	100	500	AISI 301
NI 040	0,40	100	500	AISI 301
NI 050	0,50	100	500	AISI 301
NI 060	0,60	100	500	AISI 301
NI 070	0,70	100	500	AISI 301
NI 080	0,80	100	500	AISI 301
NI 100	1,00	100	500	AISI 301

* Disponibili a richiesta anche altri Formati

ACCIAIO ARMONICO INOX AISI 301

Dimensione – Size – Dimension:



500 x 500 mm



Spessore da 0,10 a 1,00 mm Dimensione 500 x 500 mm

Thickness from 0,10 to 1,00 mm Dimension 500 x 500 mm

Epaisseur du 0,10 au 1,00 mm Dimension 500 x 500 mm

 CODICE	SPESSORE	LARGHEZZA	LUNGHEZZA	MATERIALE
 CODE	THICKNESS	WIDTH	LENGHT	MATERIAL
 CODE	EPAISSEUR	LARGEUR	LONGEUR	MATERIEL
NI 010 500	0,10	586	500	AISI 301
NI 020 500	0,20	500	500	AISI 301
NI 025 500	0,25	476	500	AISI 301
NI 030 500	0,30	500	500	AISI 301
NI 040 500	0,40	500	500	AISI 301
NI 050 500	0,50	500	500	AISI 301
NI 060 500	0,60	500	500	AISI 301
NI 070 500	0,70	500	500	AISI 301
NI 080 500	0,80	500	500	AISI 301
NI 100 500	1,00	500	500	AISI 301

* Disponibili a richiesta anche altri Formati

ACCIAIO ARMONICO INOX AISI 301

Dimensione – Size – Dimension:



500 x 1000 mm



Spessore da 0,10 a 1,00 mm Dimensione 500 x 1000 mm

Thickness from 0,10 to 1,00 mm Dimension 500 x 1000 mm

Epaisseur du 0,10 au 1,00 mm Dimension 500 x 1000 mm

 CODICE	SPESSORE	LARGHEZZA	LUNGHEZZA	MATERIALE
 CODE	THICKNESS	WIDTH	LENGHT	MATERIAL
 CODE	EPAISSEUR	LARGEUR	LONGEUR	MATERIEL
NI 010 1000	0,10	586	1000	AISI 301
NI 020 1000	0,20	500	1000	AISI 301
NI 025 1000	0,25	476	1000	AISI 301
NI 030 1000	0,30	500	1000	AISI 301
NI 040 1000	0,40	500	1000	AISI 301
NI 050 1000	0,50	500	1000	AISI 301
NI 060 1000	0,60	500	1000	AISI 301
NI 070 1000	0,70	500	1000	AISI 301
NI 080 1000	0,80	500	1000	AISI 301
NI 100 1000	1,00	500	1000	AISI 301
NI 150 1000	1,50	600	1000	AISI 301
NI 200 1000	2,00	500	1000	AISI 301

* Disponibili a richiesta anche altri Formati.

ACCIAIO ARMONICO INOX AISI 301

Dimensione – Size – Dimension:



500 x 2000 mm



Spessore da 0,10 a 1,00 mm Dimensione 500 x 2000 mm

Thickness from 0,10 to 1,00 mm Dimension 500 x 2000 mm

Epaisseur du 0,10 au 1,00 mm Dimension 500 x 2000 mm

 CODICE	SPESSORE	LARGHEZZA	LUNGHEZZA	MATERIALE
 CODE	THICKNESS	WIDTH	LENGHT	MATERIAL
 CODE	EPAISSEUR	LARGEUR	LONGEUR	MATERIEL
NI 010 2000	0,10	586	2000	AISI 301
NI 020 2000	0,20	500	2000	AISI 301
NI 025 2000	0,25	476	2000	AISI 301
NI 030 2000	0,30	500	2000	AISI 301
NI 040 2000	0,40	500	2000	AISI 301
NI 050 2000	0,50	500	2000	AISI 301
NI 060 2000	0,60	500	2000	AISI 301
NI 070 2000	0,70	500	2000	AISI 301
NI 080 2000	0,80	500	2000	AISI 301
NI 100 2000	1,00	500	2000	AISI 301
NI 150 2000	1,50	600	2000	AISI 301
NI 200 2000	2,00	500	2000	AISI 301

* Disponibili a richiesta anche altri Formati



LWP Engineering s.r.l.

PI e CF 02538780343 - Via Berlinguer, 6 - 43038 Sala Baganza (Parma)

Tel e Fax: +39 0521/834833

E-mail : info@lwpengineering.com

www.lwpengineering.com

ACCIAIO ARMONICO INOX AISI 316 L

SPRING SYSTEM



BANDELLE IN ACCIAIO ARMONICO INOX AISI 316 L



HARMONIC STAINLESS SPRING STEEL STRIP AISI 316 L



FEUILLES D'ACIER INOX POUR RESSORT AISI 316 L



LWP Engineering s.r.l.

PI e CF 02538780343 - Via Berlinguer, 6 - 43038 Sala Baganza (Parma)

Tel e Fax: +39 0521/834833

E-mail : info@lwpengineering.com

www.lwpengineering.com

ACCIAIO ARMONICO INOX AISI 316 L

Dimensione – Size - Dimension:



100 x 500 mm



Spessore 0,30 e 0,50 mm Dimensione 100 x 500 mm

Thickness 0,30 and 0,50 mm Dimension 100 x 500 mm

Epaisseur 0,30 et 0,50 mm Dimension 100 x 500 mm

 CODICE	SPESSORE	LARGHEZZA	LUNGHEZZA	MATERIALE
 CODE	THICKNESS	WIDTH	LENGHT	MATERIAL
 CODE	EPAISSEUR	LARGEUR	LONGEUR	MATERIEL
NI 316L 030	0,30	100	500	AISI 316 L
NI 316L 050	0,50	100	500	AISI 316 L

* Disponibili a richiesta anche altri Formati



LWP Engineering s.r.l.

PI e CF 02538780343 - Via Berlinguer, 6 - 43038 Sala Baganza (Parma)

Tel e Fax: +39 0521/834833

E-mail : info@lwpengineering.com

www.lwpengineering.com

ACCIAIO ARMONICO INOX AISI 316 L

Dimensione – Size – Dimension:



300 x 500 mm



Spessore 0,30 e 0,50 mm Dimensione 300 x 500 mm

Thickness 0,30 and 0,50 mm Dimension 300 x 500 mm

Epaisseur 0,30 et 0,50 mm Dimension 300 x 500 mm

 CODICE	SPESSORE	LARGHEZZA	LUNGHEZZA	MATERIALE
 CODE	THICKNESS	WIDTH	LENGHT	MATERIAL
 CODE	EPAISSEUR	LARGEUR	LONGEUR	MATERIEL
NI 316L 030 500	0,30	336	500	AISI 316 L
NI 316L 050 500	0,50	330	500	AISI 316 L

* Disponibili a richiesta anche altri Formati



LWP Engineering s.r.l.

PI e CF 02538780343 - Via Berlinguer, 6 - 43038 Sala Baganza (Parma)

Tel e Fax: +39 0521/834833

E-mail : info@lwpengineering.com

www.lwpengineering.com

ACCIAIO ARMONICO INOX AISI 316 L

Dimensione – Size – Dimension:



300 x 1000 mm



Spessore 0,30 e 0,50 mm Dimensione 300 x 1000 mm

Thickness 0,30 and 0,50 mm Dimension 300 x 1000 mm

Epaisseur 0,30 et 0,50 mm Dimension 300 x 1000 mm

 CODICE	SPESSORE	LARGHEZZA	LUNGHEZZA	MATERIALE
 CODE	THICKNESS	WIDTH	LENGHT	MATERIAL
 CODE	EPAISSEUR	LARGEUR	LONGEUR	MATERIEL
NI 316L 030 1000	0,30	336	1000	AISI 316 L
NI 316L 050 1000	0,50	330	1000	AISI 316 L

* Disponibili a richiesta anche altri Formati.



LWP Engineering s.r.l.

PI e CF 02538780343 - Via Berlinguer, 6 - 43038 Sala Baganza (Parma)

Tel e Fax: +39 0521/834833

E-mail : info@lwpengineering.com

www.lwpengineering.com

ACCIAIO ARMONICO INOX AISI 316 L

Dimensione – Size – Dimension:



300 x 2000 mm



Spessore 0,30 e 0,50 mm Dimensione 300 x 2000 mm

Thickness 0,30 and 0,50 mm Dimension 300 x 2000 mm

Epaisseur 0,30 et 0,50 mm Dimension 300 x 2000 mm

 CODICE	SPESSORE	LARGHEZZA	LUNGHEZZA	MATERIALE
 CODE	THICKNESS	WIDTH	LENGHT	MATERIAL
 CODE	EPAISSEUR	LARGEUR	LONGEUR	MATERIEL
NI 316L 030 2000	0,30	336	2000	AISI 316 L
NI 316L 050 2000	0,50	330	2000	AISI 316 L

* Disponibili a richiesta anche altri Formati



LWP Engineering s.r.l.

PI e CF 02538780343 - Via Berlinguer, 6 - 43038 Sala Baganza (Parma)

Tel e Fax: +39 0521/834833

E-mail : info@lwpengineering.com

www.lwpengineering.com

ACCIAIO ARMONICO C67s - C75s

SPRING SYSTEM

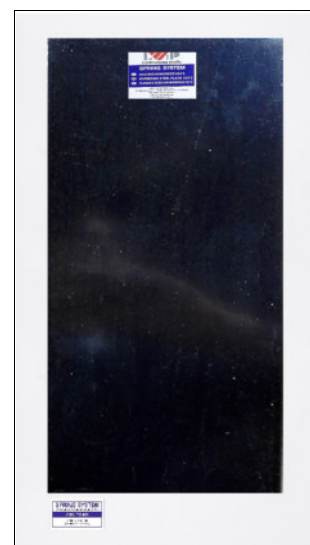
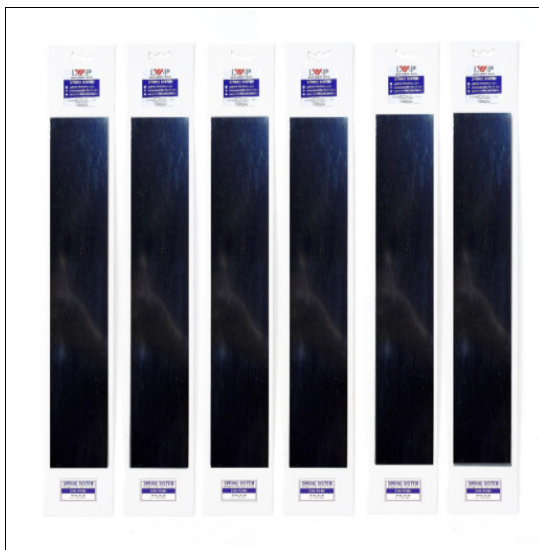

BANDELLE IN **ACCIAIO ARMONICO C67s-C75s**



HARMONIC **SPRING STEEL STRIP C67s - C75s**



FEUILLES D'**ACIER PUOR RESSORTS C67s - C75s**

ACCIAIO ARMONICO TEMPRATO C67s

Dimensione – Size - Dimension:

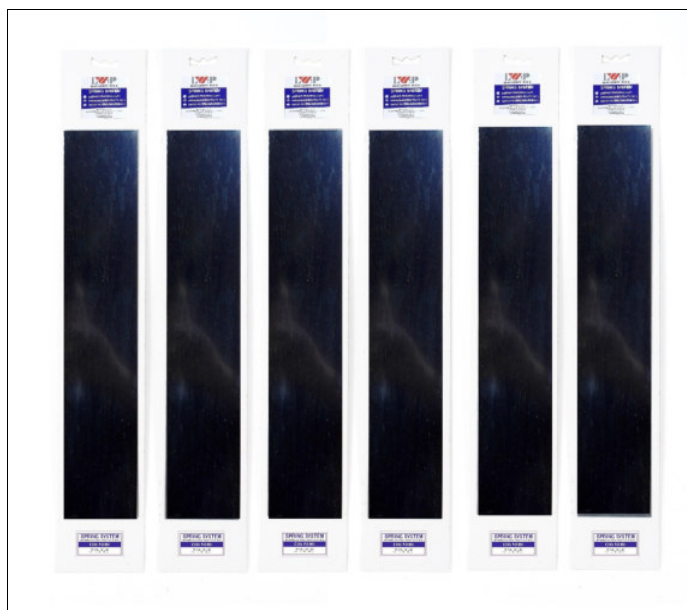

100 x 500 mm



Spessore da 0,20 a 1,00 mm Dimensione 100 x 500 mm

Thickness from 0,20 to 1,00 mm Dimension 100 x 500 mm

Epaisseur du 0,20 au 1,00 mm Dimension 100 x 500 mm

 CODICE	SPESSORE	LARGHEZZA	LUNGHEZZA	MATERIALE
 CODE	THICKNESS	WIDTH	LENGHT	MATERIAL
 CODE	EPAISSEUR	LARGEUR	LONGEUR	MATERIEL
NB 020	0,20	100	500	C67s
NB 025	0,25	100	500	C67s
NB 030	0,30	100	500	C67s
NB 040	0,40	100	500	C67s
NB 050	0,50	100	500	C67s
NB 060	0,60	100	500	C67s
NB 070	0,70	100	500	C67s
NB 080	0,80	100	500	C67s
NB 100	1,00	100	500	C67s

* Disponibili a richiesta anche altri formati.



LWP Engineering s.r.l.

PI e CF 02538780343 - Via Berlinguer, 6 - 43038 Sala Baganza (Parma)

Tel e Fax: +39 0521/834833

E-mail : info@lwpengineering.com

www.lwpengineering.com

ACCIAIO ARMONICO TEMPRATO C67s - C75s

Dimensione – Size – Dimension:

500 x 2000 mm – 650 x 2000 mm

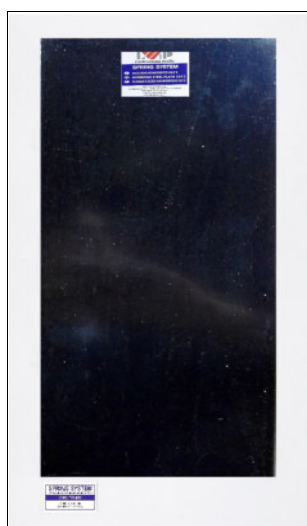

Spessore da 0,20 a 5,00 mm Dimensione 500 e 650 x 2000 mm

Thickness from 0,20 to 5,00 mm Dimension 500 and 650 x 2000 mm

Epaisseur du 0,20 au 1,00 mm Dimension 500 et 650 x 2000 mm

 CODICE	SPESSORE	LARGHEZZA	LUNGHEZZA	MATERIALE
 CODE	THICKNESS	WIDTH	LENGHT	MATERIAL
 CODE	EPAISSEUR	LARGEUR	LONGEUR	MATERIEL
NB 020 2000	0,20	305	2000	C67s
NB 030 2000	0,30	200	2000	C67s
NB 050 2000	0,50	500	2000	C75s
NB 080 2000	0,80	500	2000	C75s
NB 100 2000	1,00	500	2000	C75s
NB 120 2000	1,20	500	2000	C75s
NB 150 2000	1,50	500	2000	C75s
NB 150 650	1,50	650	2000	C75s
NB 200 2000	2,00	500	2000	C75s
NB 200 650	2,00	650	2000	C75s
NB 250 2000	2,50	500	2000	C75s
NB 300 2000	3,00	500	2000	C75s
NB 300 650	3,00	650	2000	C75s
NB 350 2000	3,50	500	2000	C75s
NB 400 2000	4,00	500	2000	C75s
NB 500 650	5,00	650	2000	C75s



LWP Engineering s.r.l.

PI e CF 02538780343 - Via Berlinguer, 6 - 43038 Sala Baganza (Parma)

Tel e Fax: +39 0521/834833

E-mail : info@lwpengineering.com

www.lwpengineering.com

ACCIAIO ARMONICO C100

SPRING SYSTEM

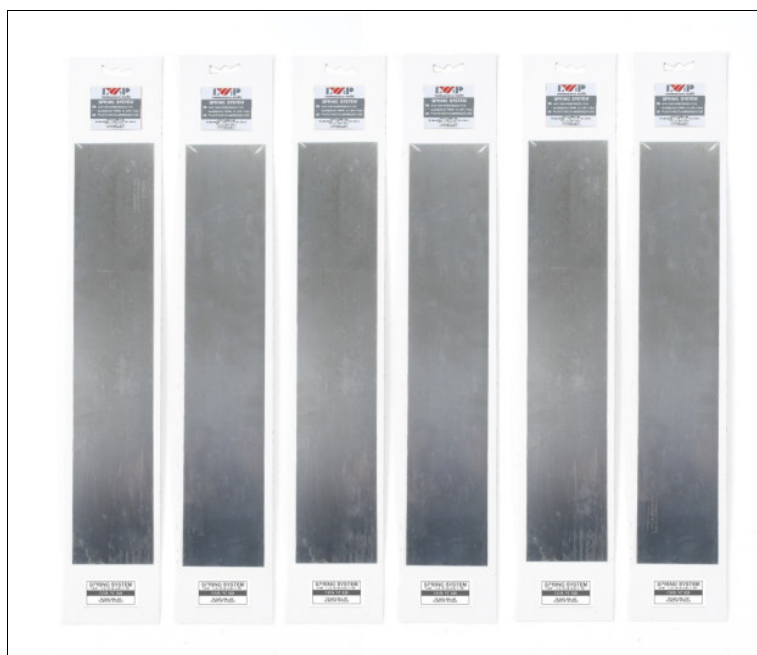

BANDELLE IN ACCIAIO ARMONICO C100



HARMONIC SPRING STEEL STRIP C100



FEUILLES D'ACIER PUOR RESSORT C100

ACCIAIO ARMONICO TEMPRATO C100

Dimensione – Size - Dimension:

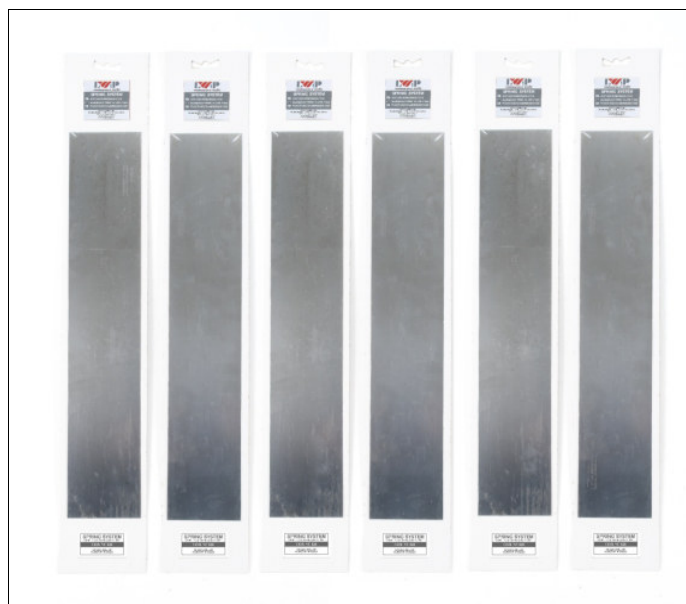

100 x 500 mm



Spessore da 0,05 a 0,50 mm Dimensione 100 x 500 mm

Thickness from 0,05 to 0,50 mm Dimension 100 x 500 mm

Epaisseur du 0,05 au 0,50 mm Dimension 100 x 500 mm

 CODICE	SPESSORE	LARGHEZZA	LUNGHEZZA	MATERIALE
 CODE	THICKNESS	WIDTH	LENGHT	MATERIAL
 CODE	EPAISSEUR	LARGEUR	LONGEUR	MATERIEL
NC 005	0,05	100	500	C100
NC 010	0,10	100	500	C100
NC 015	0,15	100	500	C100
NC 020	0,20	100	500	C100
NC 025	0,25	100	500	C100
NC 030	0,30	100	500	C100
NC 040	0,40	100	500	C100
NC 050	0,50	100	500	C100

* Disponibili a richiesta altri formati.



LWP Engineering s.r.l.

PI e CF 02538780343 - Via Berlinguer, 6 - 43038 Sala Baganza (Parma)

Tel e Fax: +39 0521/834833

E-mail : info@lwpengineering.com

www.lwpengineering.com



PRODOTTI LWP ENGINEERING S.r.l.



ALL PRODUCT LWP ENGINEERING S.r.l.



TOUS LES PRODUITS LWP ENGINEERING S.r.l.

- **MOLLE INDUSTRIALI** – *INDUSTRIAL SPRINGS – RESSORTS INDUSTRIEL*
- **ACCIAIO ARMONICO** – *SPRING STEEL STRIP – FEUILLARD D'ACIER POUR RESSORT*
- **SPRING SYSTEM** – *SPRING SYSTEM – SPRING SYSTEM*
- **RICAMBI BEVERAGE E INDUSTRIA DELLA CARNE** - *SPARE PARTS FOR BEVERAGE AND MEAT INDUSTRY - PIECES DE RECHANGE BEVERAGE ET INDUSTRIE DE LA VIANDE.*
- **IMPIANTI DI IMBOTTIGLIAMENTO** – *BOTTLING MACHINERY - EMBOUTEILLAGE*
- **PROGETTI SPECIALI** – *SPECIAL PROJECT – PROJECT SPECIAUX:*

PER MAGGIORI INFORMAZIONI VISITATE IL NOSTRO SITO:

FOR MORE INFO VISIT OUR WEBSITE:POUR PLUS D'INFORMATIONS VISITEZ NOTRE SITE WEB:

www.lwpengineering.com



Molle Industriali



Molle In Acciaio Armonico

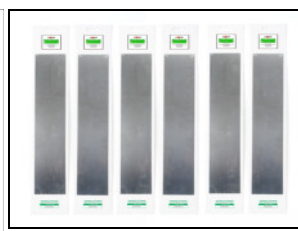

Acciaio Armonico Spring System



Molle in Spezzone Spring System



Filo Armonico Spring System



Granulatore



Imbottigliatrice LWP



Schiumatore per Impianti Birra



Ricambi Beverage



Aghi Inteneritrici



LED Custom



LWP Engineering s.r.l.

Via Berlinguer n°6, 43038 – Sala Baganza (PR)

Tel / Fax +39 0521 834833

info@lwpengineering.com www.lwpengineering.com